

***NEW YORK STATE  
DEPARTMENT OF TRANSPORTATION  
REGION 8***



***STORMWATER FACILITIES***

***OPERATIONS & MAINTENANCE MANUAL***

***SEPTEMBER 2003***

Page intentionally left blank for two-sided printing.

## About the Manual

---

This **manual** is intended to give general maintenance guidelines to stormwater facilities that will increasingly be added to DOT construction projects. The whole stormwater management issue is still developing and in its early stages and changes and improvements will be made especially in the next coming years.

In the manual, each facility has a short description of its intent, general structural features, maintenance and inspection items and a representative graphic sample. Please keep in mind that these are merely meant for illustration purposes and cannot replace the drawing that goes with the original design.

DOT Region 8 is addressing the need to maintain these facilities through the implementation of a Stormwater Facilities Maintenance contract. As of 2003, two contracts have been let for approximately 80 facilities. In the meantime, many more facilities are being added and the total number of these is destined to increase exponentially in the future.

A good understanding of these measures is required by designers, construction, inspection and maintenance personnel involved in all aspects of these facilities. This manual focuses mainly on the maintenance aspects. However, a designer familiar with maintenance needs will be able to design a structure that will last longer due to well thought-out maintenance provisions.

Page intentionally left blank for two-sided printing.

## Contents:

I.	Introduction .....	1
II.	Some Resources.....	5
III.	Stormwater Facilities- Selected Practices with Representative Drawing, Description, Maintenance and Inspection Requirements	
A.	Stormwater Pond - SP*.....	7
B.	Stormwater Wetland - SW.....	9
C.	Dry Extended Detention Basin - DED..... Dry Pond - DP	11
D.	Infiltration Basin, Grassy - IBG.....	13
E.	Infiltration Trench - ITR.....	15
F.	Sand Filter - SF.....	17
G.	Bioretention Filter - BIO.....	19
H.	Filter Strip - ..... Grassy - FSG Vegetated - FSV	21
I.	Dry Swale - DSW.....	23
J.	Wet Swale - WSW.....	25
K.	Checkdam - CD.....	27
L.	Oil/Grit Separator - OGS.....	29
M.	Water Quality Catch Basin QCB.....	31
N.	Diversion Structure - DS.....	33
O.	Trash Rack - TR.....	35
P.	Stone-Lined Ditch - SD.....	37
Q.	Grass Channel - GC- ..... with Checkdams - GCD	39
IV.	Inspection Checklists	
A.	Stormwater Pond/Wetland, Detention Basin and Dry Pond.....	42
B.	Infiltration Practices, Trench and Basin.....	48
C.	Sand and Organic Filter.....	50
D.	Bioretention Filter.....	52
E.	Open Channel, Dry Swale, Wet Swale, Stone-Lined Ditch, Grass Channel.....	54
V.	Stormwater Facilities - Activation and Inventory Form.....	56
VI.	Rainfall List by County in NYSDOT Region 8.....	57
VII.	NYSDOT Region 8 Contacts.....	Inside Back Cover

\* Abbreviations used in serial numbering system of stormwater facilities database.

## Introduction

---

### The Regulations

Since the passage of the Clean Water Act in 1972, significant water quality achievements have been made. Despite this progress, degraded water bodies still exist. A leading source of impairment is polluted runoff from urban and suburban areas. According to U.S. Environmental Protection Agency (EPA), contaminated stormwater is the largest source of water pollution for our coastal waters and the second largest source of water pollution for our estuaries. Stormwater is also the largest known source of beach closures and advisories nationwide. Management of this polluted runoff, especially in urban areas, is becoming a necessary step in seeking further reducing pollution in our waterways.

A federal regulation, commonly known as Stormwater Phase Final II, published in the Federal Register on December 8, 1999, aims at reducing polluted stormwater runoff. It requires permits for stormwater discharges from Municipal Separate Storm Sewer Systems (MS4s) in urbanized areas and for construction activities disturbing one or more acres. To implement the law, the New York State Department of Environmental Conservation has issued two general permits, one for MS4s in urbanized areas and one for construction activities. The permits are part of the State Pollutant Discharge Elimination System (SPDES) and referred to as “SPDES 2”.

SPDES 2, which came into effect in 2003, regulates DOT as a MS4 and requires permits for construction sites with greater than one-acre disturbances. Before SPDES 2, the Department had to abide by SPDES 1. SPDES 1 was released in 1993 and targeted construction sites with more than five-acre disturbances. DOT was not considered a MS4 under that regulation.

Many DOT projects disturb more than one-acre and by the new regulations, require detailed erosion and sediment control plans for the construction phase of the project. Post-construction conditions have to be addressed as well. Permanent stormwater management facilities will treat stormwater running off the newly created impervious surfaces before being released to the waterways. This manual addresses the maintenance of these permanent facilities that are destined to speckle DOT’s landscape in the coming years.

### What is Stormwater?

Stormwater is water from rain or melting snow that doesn't soak into the ground but runs off into waterways. It flows from rooftops, over paved areas and bare soil, and through sloped lawns while picking up a variety of materials on its way. As it flows, stormwater runoff collects and transports soil, animal waste, salt, pesticides, fertilizers, oil and grease, debris and other potential pollutants.

Stormwater pollution from nonpoint sources is a challenging water quality problem. Unlike pollution from industry or sewage treatment facilities, which is caused by a discrete number of sources, stormwater pollution is caused by the daily activities of people everywhere.

Stormwater from **construction sites** is of water quality concerns because of the devastating effects that sedimentation can have on local waterbodies, particularly small streams. In addition to sediment, construction sites can yield pollutants such as pesticides, petroleum products, solvents, acids and asphalts. Sediment-laden runoff can result in streambed scour, streambank erosion, loss of in-stream habitat for fish and aquatic species, and drinking water degradation. Nutrients such as phosphorus and nitrogen can promote the overgrowth of algae, deplete oxygen in the waterway and be harmful to other aquatic life.

Beside construction activities, highway departments contribute to stormwater pollution through the creation of **paved surfaces**. Paving over naturally porous surfaces, such as forests, and fields, causes pollutants to collect on these and increase overland flow. Studies have shown that roads contribute a large number of pollutants to urban runoff - metals, used motor oil, grease, coolants and antifreeze, spilled gasoline, nutrients from vehicle exhaust, and sediment. Highways can increase the annual volume of stormwater discharges by up to 16 times the pre-development rate, which threatens downstream areas with flooding and erosion.

### **Design**

With downsized maintenance forces, stormwater facilities maintenance will be contracted out. However, the designer should keep in mind that easily maintained facilities will go a long way. Here are some of the points designers should consider:

- T Discuss proposed facilities with the Maintenance Environmental Coordinator and Residency personnel.
- T Make facilities visible. Visible structures get more attention.
- T Select low-growing suitable grasses to reduce mowing needs. Add some nitrogen fixing plants such as clover to reduce fertilizing needs.
- T Incorporate reference points into basins and other features that require clean-out in regard to an absolute elevation. How would someone know how much sediment has accumulated? Percentage of capacity reduction is difficult to estimate.
- T Consider mosquito control such as introducing natural predators into a permanent pool (for example mosquito eating fish) or placing commercial mosquito traps.
- T Features to be maintained must be accessible. Consider access roads, ramps to basin bottoms, sturdy slopes.
- T Trash racks should be accessible at normal pool elevations.
- T Do not plant trees and shrubs on embankments, side slopes or dam areas.
- T Slopes that should be mowed should be 1 on 3 or flatter. If slope is higher than 5 feet, slope should be 1 on 4 or flatter. If steeper, explore other treatment options.
- T For non-vegetated covers, loose stone or rip rap, which encourages the growth of weeds, should be discouraged. Can consider using gabion lining.
- T Consider effects of sediment removal from vegetated surfaces. Can vegetative cover recuperate on its own?
- T Aesthetic features of the stormwater management facilities requested by municipalities should be maintained by the requester. Commitments by municipalities must be made by signed resolutions.

Pertinent information should clearly be passed along with the project. At the time of PS&E, designers must fill out the facilities inventory and activation form, which will be linked to the

stormwater facilities database managed by the Maintenance Environmental Coordinator. This inventory and activation form will also include a maintenance requirements section. It is advisable to use this Operations and Maintenance Manual as a guide. If maintenance other than what is described herein is necessary, alternative maintenance measures must be indicated.

Stormwater facilities should clearly be shown on contract plans and details. Information on whether a facility is designed to permanently hold water, detain it for less than 48 hours, or infiltrate only, etc. should be given. Descriptive labels such as "Infiltration Basin", "Dry Extended Detention Basin", etc should be used instead of "Basin 1", "Basin 2", etc.

Information from the designer is necessary to properly construct, inspect or maintain the facility.

### **Construction**

The proper construction of these facilities is key to their performance. Construction personnel must be properly trained in the technical aspects and purposes of the facilities. In addition to the Construction Environmental Coordinator (CEC) and environmental staff, a permanently assigned inspector and/or Engineer-in-Charge (EIC) must be cognizant of these measures.

Any field changes to the facilities must be discussed with the CEC, Regional Environmental Contact and the designer as it may affect permit conditions. As-builts for these facilities should be transmitted to the Maintenance Environmental Coordinator (MEC) when the project closes out. Maintenance will likely be required before the approved final as-builts are distributed and as-builts should be on-hand for this task.

Note: A Construction Manual for stormwater facilities should be written and distributed.

### **Inspection**

For the most part, inspection has been performed by DOT forces. In the past, inspectors had to make the best of their combined DOT construction inspection and maintenance experience. The Landscape/Environmental Group served as a basis for advise and guidance. Hopefully this manual will fill some of the voids encountered in the past.

Ideally, inspection should be performed before or during the growing season. Inspections are difficult if not impossible during the winter when the ground is covered by ice and snow.

In general, inspections are mandatory after 10-year or larger storms. A 10-year storm can drop between 4 and 6 inches of rainfall within 24-hours (see attached rainfall list). An annual inspection is also required for all practices.

Inspection forms have been inserted from the NYS Stormwater Design Manual and can be used for guidance. The inspector will record the condition of the facility and required work onto an electronic database form. The information will then be linked into a larger database and extracted for the maintenance contract.

### **Maintenance**

As mentioned above, maintenance of these facilities will mostly be accomplished by contract. However, there may be times when state Maintenance forces will be asked to accomplish some work, such as during a time when a contract is not available.

Maintenance forces must understand that these facilities are becoming part of normal operating procedures when constructing or improving a highway. Managers and executives must understand that any newly added responsibilities must be matched with adequate funding, staffing and equipment.

The Maintenance Environmental Coordinator (MEC) will inform the Resident Engineer of the existence, purpose and maintenance requirements of these facilities. Is a facility intended to hold water? For how long? Are slopes to be mowed? Is the basin designed to function as a wetland? Maintenance forces are most aware of events and needs within their given area and can include an occasional inspection into their busy schedules. If they are unable to perform the maintenance work, at the very least, they can make the MEC aware of maintenance or repair needs at a facility.

Resident Engineers often receive inquiries from the public and being aware of the facilities will allow them to answer knowingly. By being involved in the maintenance aspects of these facilities, Resident Engineers can provide valuable insights to design and improve the process of stormwater treatment.

Without maintenance, these measures are sure to fail. Preventative maintenance is what is required rather than the costly corrective action that would ensue by maintenance neglect.

Comments about this manual can be directed to Elisabeth Kolb, Maintenance Environmental Coordinator at 845/575-6158 or [ekolb@dot.state.ny.us](mailto:ekolb@dot.state.ny.us) .

## **Some Resources:**

---

### **Manuals**

NYS Stormwater Management Design Manual, NYS Department of Environmental Conservation, October 2001. Albany, NY.

<http://www.dec.state.ny.us/website/dow/swmanual.html>

Draft Stormwater Management Handbook for NYS DOT Projects within the NY City Watershed dated March 2000.

New York Guidelines for Urban Erosion and Sediment Control, Fourth Printing. NY State Environmental Conservation Department, USDA - Natural Resources Conservation Service. April 1997. Syracuse, NY. (New printing pending.)

Order from: Empire State Chapter of Soil and Water Conservation Society, Cayuga County Soil and Water. 7413 County House Road, Auburn. NY 13021.

\*\* Graphics were taken from above referenced manuals and from New York State Department of Transportation Region 8 Design files.

### **Internet Sites**

NYSDEC Stormwater Site:

<http://www.dec.state.ny.us/website/dow/mainpage.htm>

US EPA Stormwater Site:

<http://cfpub.epa.gov/npdes/stormwater/menuofbmps/menu.cfm>

**This page left intentionally blank for two-sided printing.**

Figure 6.2 Wet Pond (P-2)

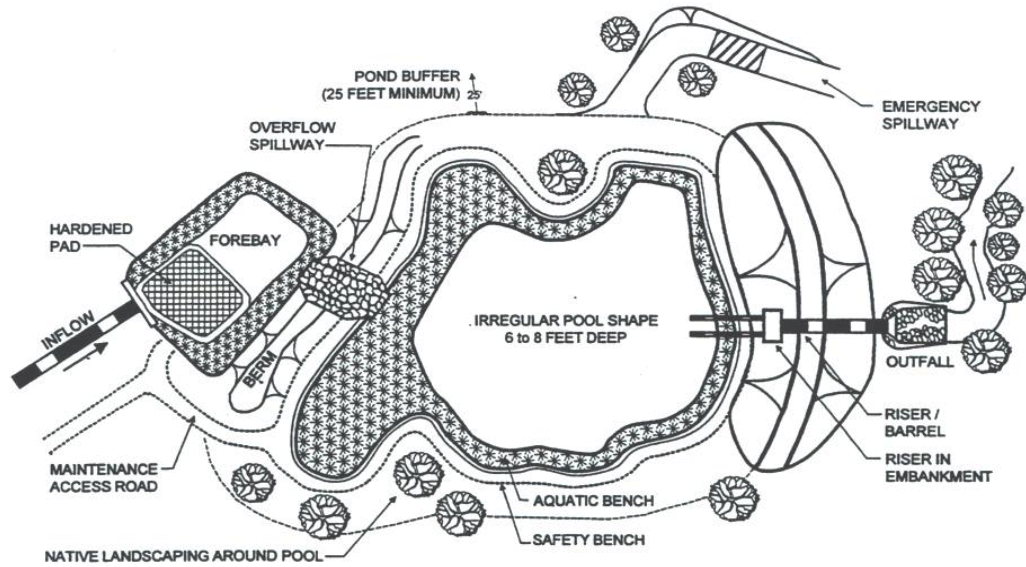

PLAN VIEW

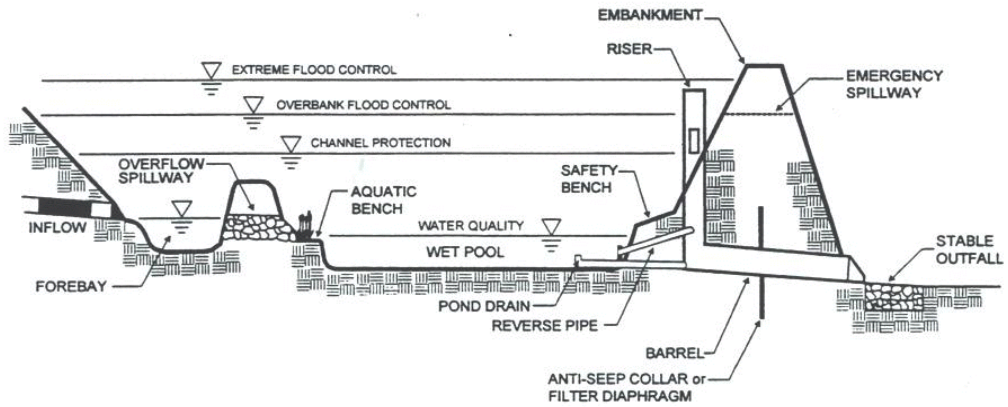

PROFILE

## A.. Stormwater Pond - SP

---

**Description:** A stormwater pond receives runoff from each rain event. Pollutants contained in the runoff are removed in a permanent pool through settling and biological uptake mechanisms. Wetland plants are often encouraged to grow along the wet edge of the pond (fringe) and in shallow pond areas. This type of pond is also called retention basin, wet pond, wet extended detention, multiple pond, pocket pond and micropool extended detention.

**Structural Features:** Inlet structure, forebay, pool with potential liner, embankments, riser or other outlet structure, stable outfall, emergency spillway, and access road.

### **Maintenance:**

- T Periodically remove debris and litter.
- T Mow side slopes, embankments, emergency spillway and access road at least once a year, preferably after August. Woody growth should be discouraged.
- T Remove woody vegetation within 15 linear feet of the toe of embankment, or 25 linear feet from the principal spillway or growing on other structural features listed above.
- T Remove sediment from forebay every five to six years or when 50% full; from pond if 10% of capacity has been lost.
- T Stabilize eroding soils of the pond side slopes, embankment, and spillway and on DOT right-of-way in the contributory drainage area by seeding and mulching or other appropriate means.
- T Repair or replace structural elements such as inlet and outlet structures as necessary.

### **Inspection:**

Inspect for:

- T Erosion, cracking, embankment subsidence, tree growth, borrowing animals.
- T Sediment and clogging in the emergency spillway and drain.
- T Sediment in forebay.
- T Adequacy of channel erosion controls at the outlet.
- T Proper functioning of structural elements.

For additional guidance, see attached **inspection checklist**.

Figure 6.7 Shallow Wetland (W-1)

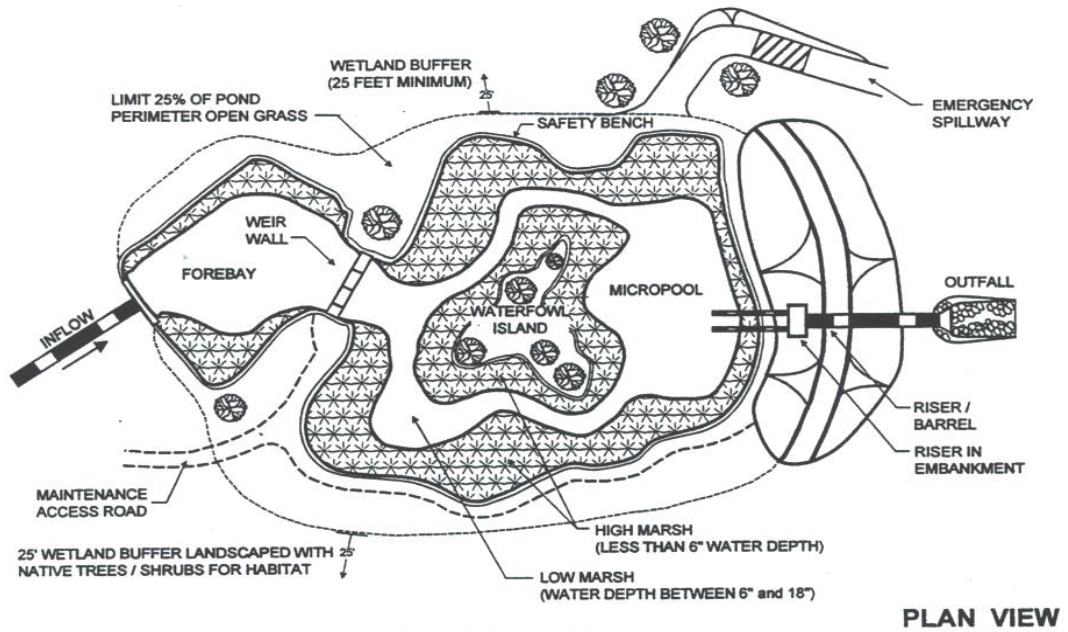

PLAN VIEW

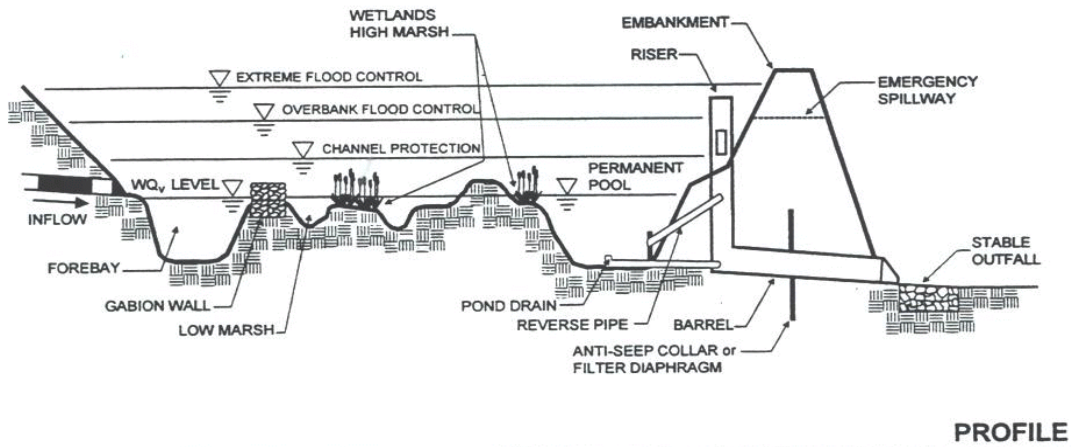

PROFILE

## **B. Stormwater Wetland - SW**

**Description:** Stormwater wetlands store and treat roadside runoff in a shallow marsh area. As stormwater travels along a long flow path through the wetland, pollutants are removed through settling and biological uptake. This facility mimics a natural environment and contributes to wildlife and waterfowl habitat and adds natural beauty to its surroundings. Stormwater wetlands are not protected under the same rules and regulations as their wetland siblings, the Federal Jurisdictional Wetlands and state-regulated wetlands.

**Structural Features:** Inlet structure, forebay, low marsh area, shallow pool with potential liner, islands, embankments, riser or other outlet structure, stable outfall, emergency spillway, and access road. Other: Wetland plantings in marsh area.

### **Maintenance:**

- T Periodically remove debris and litter.
- T Mow side slopes, embankments, emergency spillway and access road at least once a year, preferably after August. Woody growth should be discouraged.
- T Ensure that at least 50% of shallow marsh area is covered by wetland vegetation.
- T Remove woody vegetation within 15 linear feet of the toe of embankment, or 25 linear feet from the principal spillway or growing on other structural features listed above.
- T Remove sediment from forebay every five to six years or when 50% full; from wetland if 25% of capacity is lost or long flow path of water is hindered. Some replacement wetland planting may be necessary.
- T Stabilize eroding soils of pond side slopes, embankment, spillway and on DOT right-of-way in the contributory drainage area by seeding and mulching with straw or other appropriate means.
- T Repair or replace structural elements such as inlet and outlet structures as necessary.
- T Remove larger borrowing animals, such as muskrats, from structural features. Trapping may be necessary.

### **Inspection:**

Inspect for:

- T Erosion, cracking, embankment subsidence, tree growth, borrowing animals.
- T Sediment and clogging in the emergency spillway and drain.
- T Sediment in forebay.
- T Adequacy of channel erosion controls at the outlet.
- T Adequacy of plant coverage in shallow marsh (vegetated wetland) areas (50%).
- T Proper functioning of structural elements.
- T Sources of erosion in the contributory drainage area

For additional guidance, see attached **inspection checklist**.

# EXTENDED DETENTION

WATERSHED HANDBOOK
STANDARD DETAILS
EXTENDED DETENTION

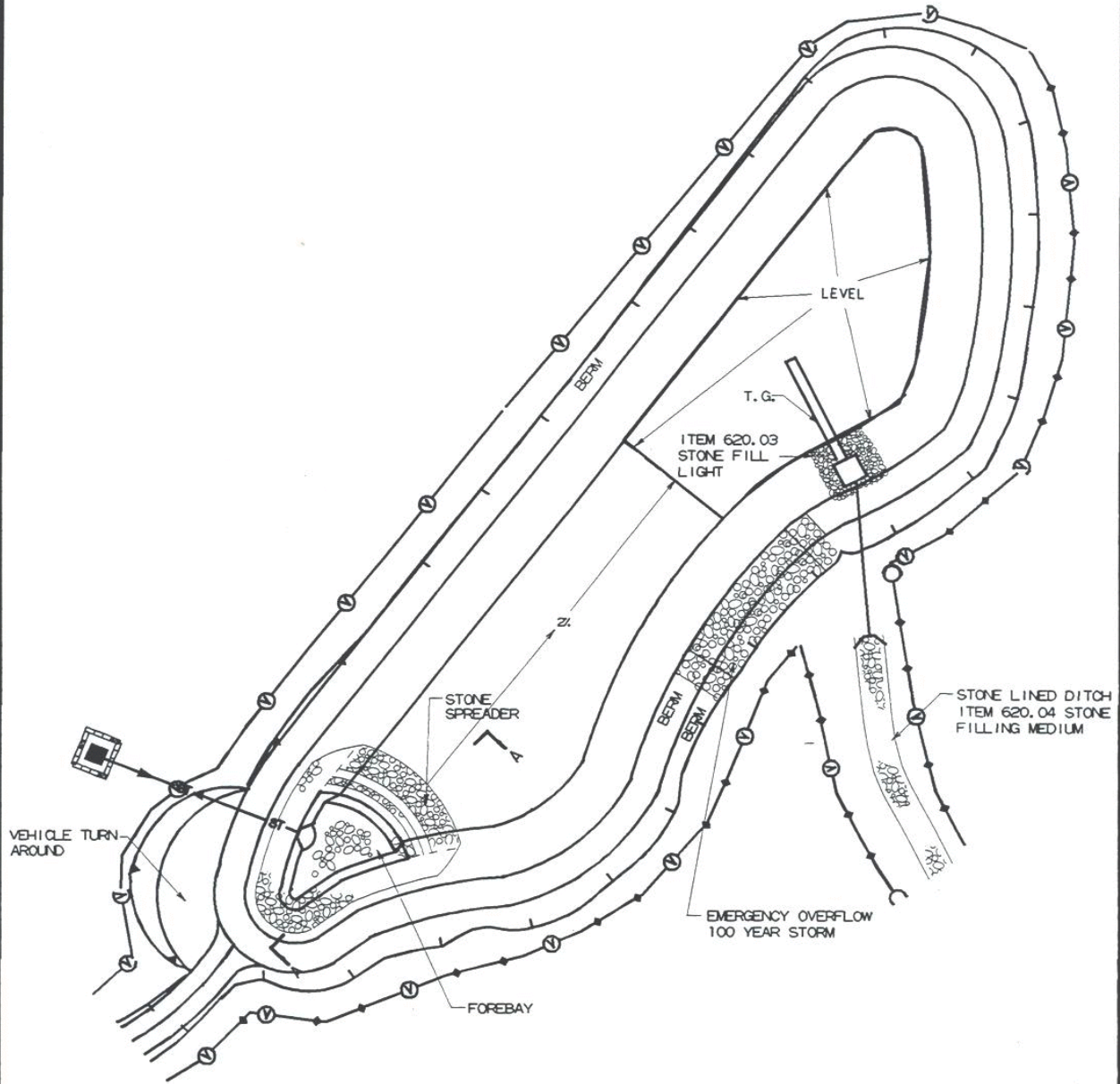

FILE NAME = V:\sotler\05011.dgn  
 DATE/TIME = 30-DEC-1999 11:48  
 USER = ewehmann

ALL DIMENSIONS ARE IN m UNLESS OTHERWISE NOTED

	STATE OF NEW YORK DEPARTMENT OF TRANSPORTATION	
	12/99	REGION EIGHT

## C. Dry Extended Detention Basin - DED and Dry Pond - DP

**Description:** Dry detention basins, also known as **dry ponds** or detention ponds, are meant to temporarily detain runoff. In general, dry ponds hold water for less than 24 hours, alleviate flooding, but do little to improve water quality.

**Structural Features:** Inlet structure, forebay, embankments, riser or other outlet structure, stable outfall, emergency spillway, and access road.

### **Maintenance:**

- T Periodically remove debris and litter.
- T Mow side slopes, basin, embankments, emergency spillway and access road at least once a year, preferably after September. Woody growth should be discouraged. Dispose of removed vegetation at an approved upland location.
- T Eroding soils on the pond side slopes, embankments, pond floor, spillway and along the DOT right-of-way in the contributory drainage area must be stabilized immediately with vegetation or appropriate erosion control practices.
- T Sediment should be removed when 10% of the pond capacity has been lost.
- T Inlet and outlet structures, and standpipe or riser structures should be replaced as necessary.

### **Inspection:**

Inspect for:

- T Evidence of outlet structure clogging
- T Erosion in the basin floor
- T Erosion, cracking or tree growth on the embankment
- T Condition of the emergency spillway
- T Accumulation of sediment around the riser
- T Adequacy of upstream and downstream channel erosion control measures
- T Sources of erosion in the contributory drainage area

For additional guidance, see attached **inspection checklist**.

Figure 6.12 Infiltration Basin (I-2)

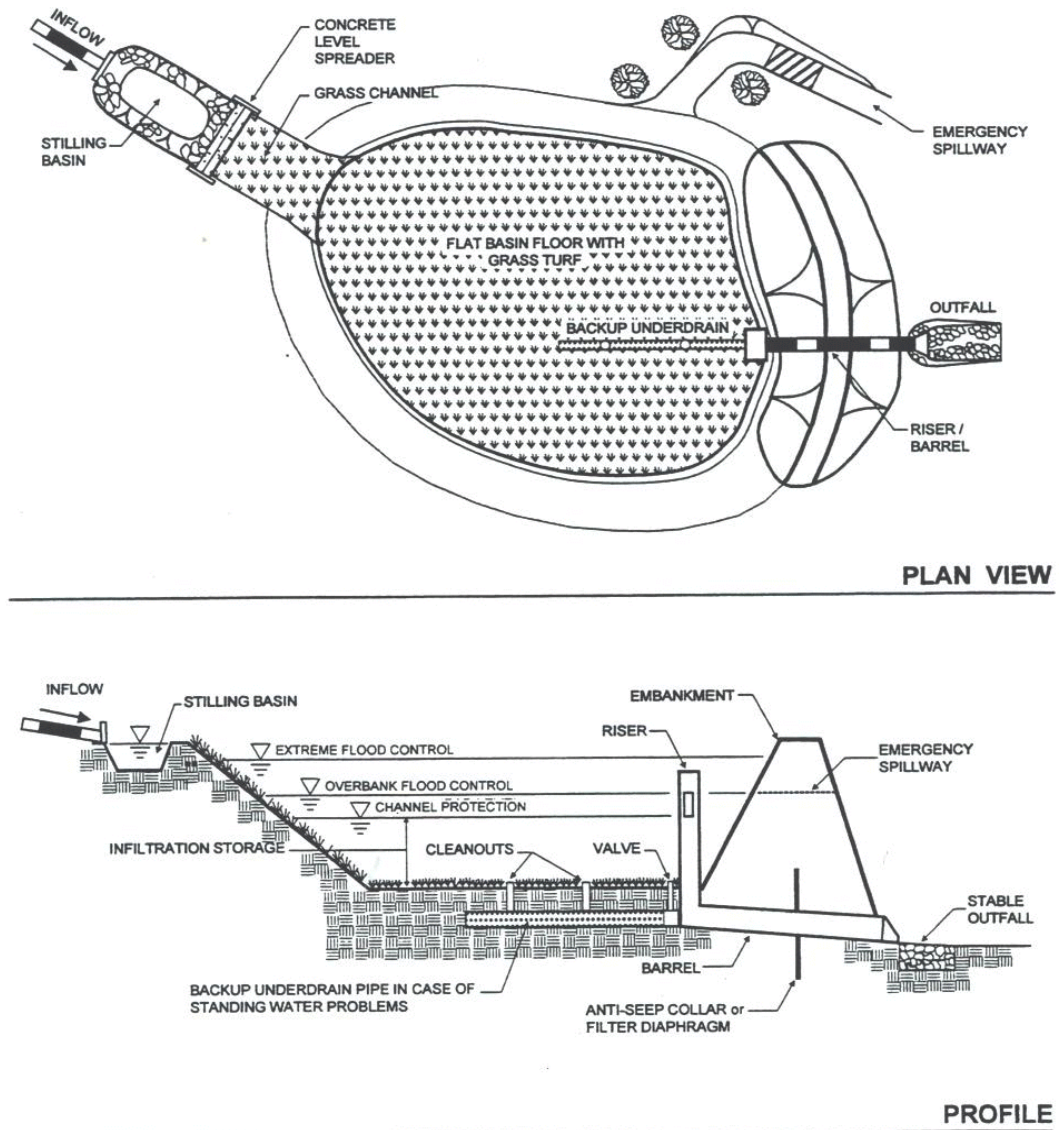

## **D. Infiltration Basin, Grassy - IBG**

**Description:** Excavated basin used to capture and allow infiltration of stormwater runoff into soils of the basin and basin sides.

**Structural Features:** Inlet structure, forebay, grass channel, embankments, grassy basin floor, riser and outlet structure, backup underdrain, stable outfall, emergency spillway, and access road.

### **Maintenance:**

- T Periodically remove debris and litter.
- T Mow basin floor, side slopes, embankments, emergency spillway and access road at least once a year. Woody growth should be discouraged. Dispose of removed vegetation at an approved upland location.
- T Remove woody vegetation within 15 linear feet of the toe of embankment, or 25 linear feet from the principal spillway or growing on other structural features listed above.
- T Remove sediment from forebay every five to six years or when 50% full; from basin when sediment has accumulated to a depth of 5 inches (125 mm).
- T Stabilize eroding soils of side slopes, embankment, basin floor, spillway and on DOT right-of-way in the contributory drainage area by seeding and mulching or other appropriate means.
- T Repair or replace structural elements such as inlet and outlet structures as necessary.
- T Remove larger borrowing animals, such as muskrats, from structural features. Trapping may be necessary.

### **Inspection:**

Inspect for:

- T Proper dewatering. Infiltration basin should be dewatered 48 hours after a storm event.
- T Erosion, cracking, embankment subsidence, tree growth, borrowing animals.
- T Sediment accumulation in the basin.
- T Sediment accumulation in forebay.
- T Adequacy of grass coverage in basin areas.
- T Proper functioning of structural elements.
- T Sources of erosion in the contributory drainage area

For additional guidance, see attached **inspection checklist**.

Figure 6.11 Infiltration Trench (I-1)

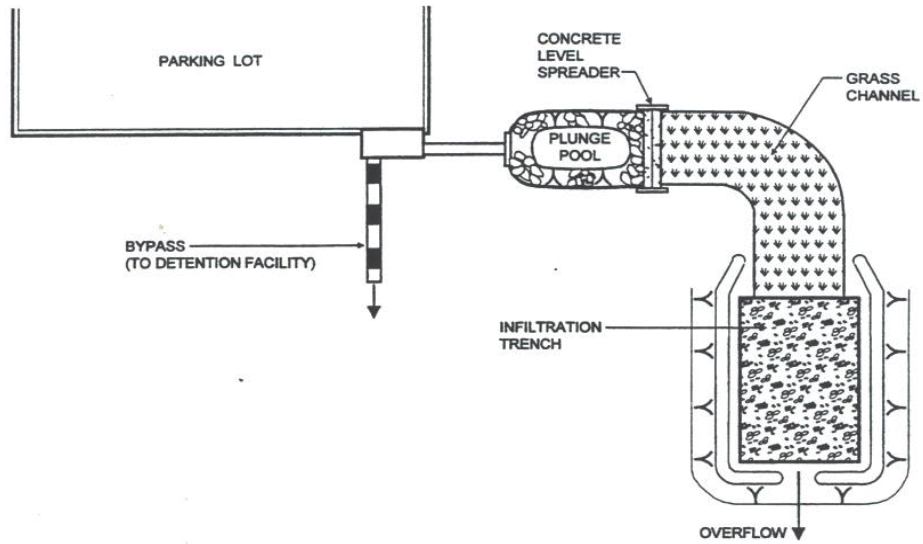

PLAN VIEW

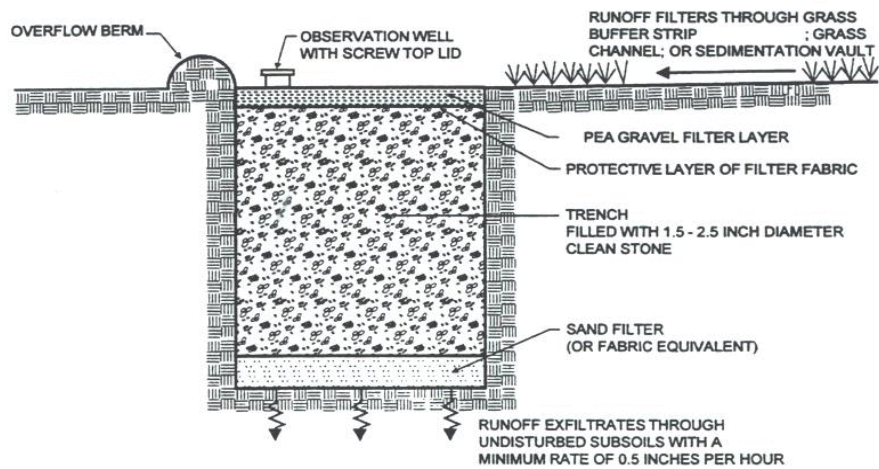

SECTION

## E. Infiltration Trench - ITR

**Description:** Same as grassy infiltration basin described (4) above, except that an infiltration trench is not vegetated. This measure usually presents a high maintenance burden.

**Structural Features:** Inlet structure, forebay, grass channel, embankments, bare basin floor, riser and outlet structure, backup underdrain, stable outfall, emergency spillway, and access road.

### **Maintenance:**

- T Periodically remove debris and litter.
- T Remove any vegetation growing on trench or basin floor.
- T Sediment should be removed and replaced when soil pores are clogged and drainage does not occur within 48 hours after a storm event.
- T Tilling may be necessary to control weed growth. And overcome the effects of soil compaction. Before tilling, sediment and vegetation must be removed. If a filter fabric is present near surface, care shall be taken not to harm it.
- T Mow side slopes, embankments, emergency spillway and access road at least once a year, preferably after August. Woody growth should be discouraged. Dispose of removed vegetation at an approved upland location.
- T Remove woody vegetation within 15 linear feet of the toe of embankment, or 25 linear feet from the principal spillway or growing on other structural features listed above.
- T Remove sediment from forebay every five to six years or when 50% full; from basin or trench when sediment has accumulated to a depth of 5 inches (125 mm) or when basin has clogged.
- T Stabilize eroding soils of side slopes, embankment, spillway and on DOT right-of-way in the contributory drainage area by seeding and mulching or other appropriate means.
- T Repair or replace structural elements such as inlet and outlet structures as necessary.
- T Remove larger borrowing animals, such as muskrats, from structural features. Trapping may be necessary.

### **Inspect for:**

- T Proper dewatering. Infiltration basin should be dewatered 48 hours after a storm event. Check observation well.
- T Erosion, cracking, embankment subsidence, tree growth, borrowing animals.
- T Sediment accumulation in the basin and forebay.
- T Proper functioning of structural elements.
- T Sources of erosion in the contributory drainage area

For additional guidance, see attached **inspection checklist**.

Figure 6.15 Surface Sand Filter (F-1)

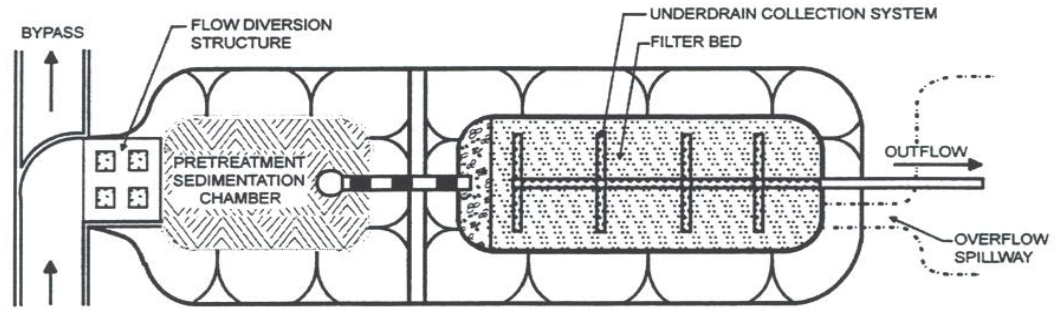

PLAN VIEW

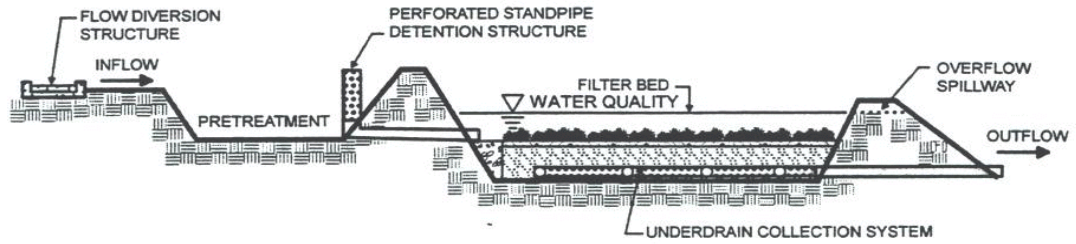

PROFILE

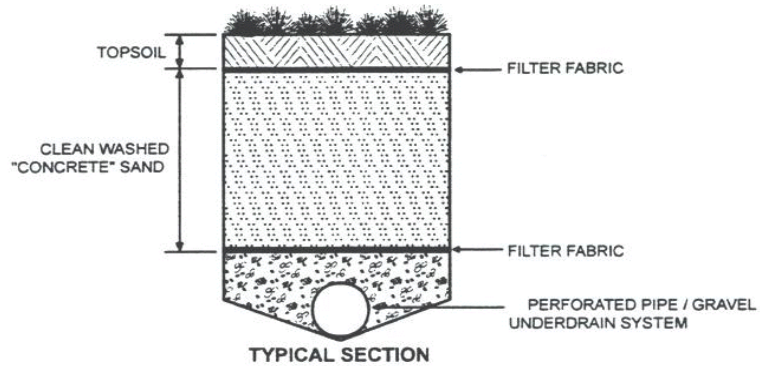

TYPICAL SECTION

## **F. Sand Filter - SF**

**Description:** Sand filtering systems capture and temporarily store stormwater and pass it through a filter bed of sand, organic matter, or soil. Filtered water usually is returned to the drainage conveyance system, but at times is allowed to partially infiltrate into the soil. These systems are usually shallow, sometimes just 12" deep and may have a grass cover. Used near parking lots.

**Structural Features:** Inlet structure, flow splitter, pre-treatment sedimentation chamber, filter bed, underdrain collection system, overflow spillway and outlet structure.

### **Maintenance:**

- T Periodically remove debris and litter.
- T If filter is vegetated with grass, mow at least 3 times per year at a maximum height of 12 inches.
- T Silt/sediment shall be removed from the filter bed when accumulation exceeds one inch. If water ponds on the filter surface for more than 48 hours, the top few inches of discolored material shall be removed and replaced with fresh material.
- T Sediment should be removed from the sedimentation chamber when 6 inches have accumulated at the bottom.
- T Tilling may be necessary to control weed growth. And overcome the effects of soil compaction. Before tilling, sediment and vegetation must be removed.
- T Repair or replace structural elements such as inlet and outlet structures as necessary.
- T Stabilize eroding soils of upstream areas, slopes, embankments, inflow area and DOT right-of-way by seeding and mulching or other appropriate means.

### **Inspection:**

Inspect for:

- T Proper dewatering. Infiltration basin should be dewatered 48 hours after a storm event.
- T Sediment accumulation in the sand filter.
- T Soil compaction.
- T Sediment accumulation in sedimentation chamber.
- T Height of grass, if applicable.
- T Proper functioning of structural elements.
- T Sources of erosion in the contributory drainage area

For additional guidance, see attached **inspection checklist**.

Figure 6.19 Bioretention (F-5)

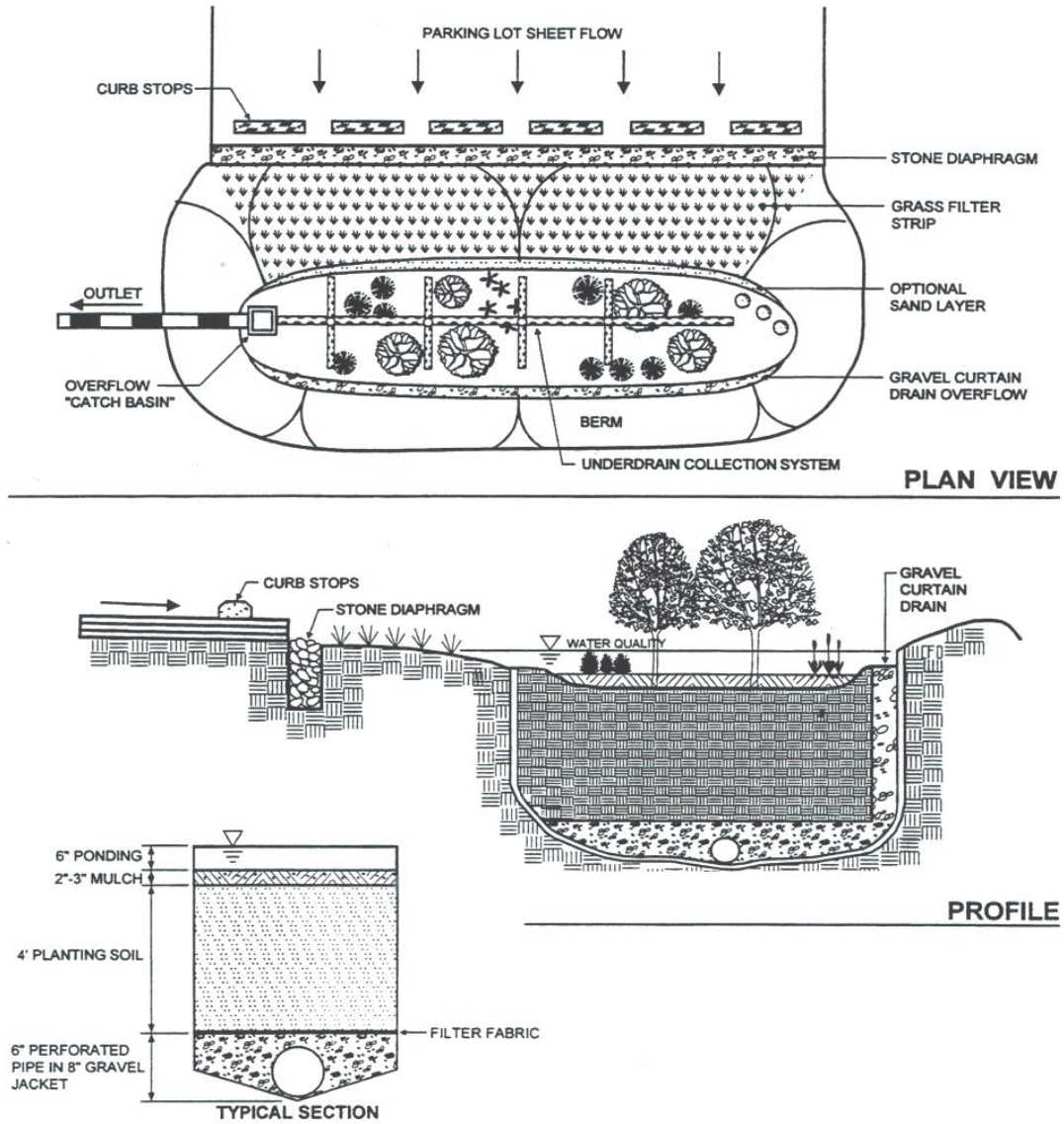

## **G. Bioretention Filter - BIO**

**Description:** Similar to sand filtering practices (F). The bioretention filter is vegetated with native trees, shrubs and herbs. Contains a layer of mulch and planting soil.

**Structural Features:** Stone drop, grass filter strip, bioretention filter with underdrain, outlet structure.

### **Maintenance:**

- H. Periodically remove debris and litter.
- I. Remove sediment when buildup exceeds 3 inches.
- J. Vegetation may need pruning for safe sight distances.
- K. Replenish mulch layer to its original depth every two years. The removed mulch layer shall be properly disposed of or roto-tilled into the surface. Ensure that mulch does not contain seeds of plants considered invasive in New York State.
- L. If the filter has compacted and standing water is observed 48 hours after a storm event, till the top 6 inches of the filter. Replace mulch.
- M. Snake and flush the underdrain system to remove any blockages, if water is not draining within 48 hours after storm event.
- N. Thin herbaceous rootstock, if plants are overcrowding the access.
- O. Repair or replace structural elements including inlet and outlet structures as necessary.
- P. Stabilize eroding soils of upstream areas, slopes, embankments, inflow area and DOT right-of-way by seeding and mulching or other appropriate means.
- Q. Stabilize any erosion gullies in bioretention area.

### **Inspection:**

Inspect for:

- T Proper dewatering. Bioretention basin should be dewatered 48 hours after a storm event.
- T Sediment accumulation in excess of three inches.
- T Soil compaction.
- T Sediment in stone drop.
- T Mulch - has it been replaced in the last two years or does it require replenishing?
- T Sight visibility issues of vegetation. Overcrowding of rootstock.
- T Proper functioning of structural elements.
- T Sources of erosion in the contributory drainage area

For additional guidance, see attached **inspection checklist**.

FILE NAME = c:\user\sbushnee\sr\wrk\water\shop\filterstrip.dtl  
 DATE/TIME = 17-MAR-2000 13:06  
 USER = bushnee

WATERSHED HANDBOOK
STANDARD DETAILS
FILTER STRIP DETAIL

### FILTER STRIP DETAIL

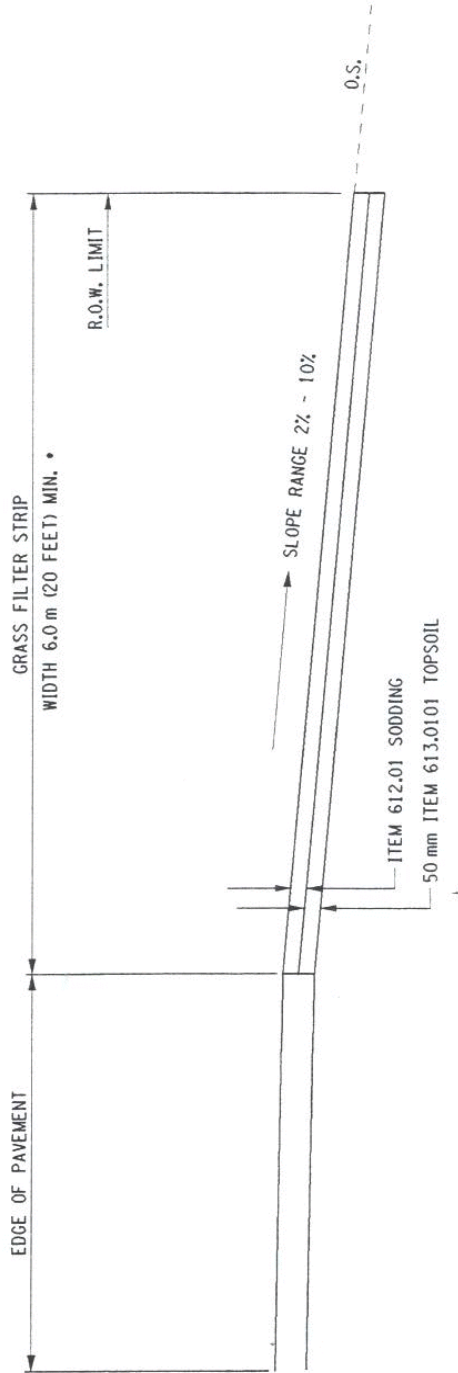

- WIDTH CONTROL 6.0 m (20 FT) MIN. SLOPES 2%-5%, ADD 1.2 m (4 FT) FOR EACH ADDITIONAL % UP TO A MAX. SLOPE OF 10%.

ALL DIMENSIONS ARE IN m UNLESS OTHERWISE NOTED

 STATE OF NEW YORK DEPARTMENT OF TRANSPORTATION	12/99	REGION EIGHT

## H. Filter Strip - Grassy (FSG) and Vegetated (FSV)

**Description:** Filter strips, which can be **grassed** (FSG) or **vegetated** filters (FSV), are sloping surfaces that are designed to treat sheet flow from adjacent surfaces and remove pollutants through infiltration. In essence, grass filter strips (FSGs) are patches of densely growing grasses. Vegetated filter strips (FSVs) are host to natural growth including trees and shrubs.

**Structural Features:** Even sloping surface, vegetation, either grass or natural growth including trees and shrubs.

### **Maintenance:**

- T Periodically remove debris and litter.
- T Mow grassy filter strips at least once per year. Vegetated filter strips should not be mowed in order to allow for natural succession.
- T Periodically remove sediment in order to maintain original design depth. Sediment must be removed manually in order to retain original grade.
- T Stabilize eroding soils on DOT right-of-way in the contributory drainage area by seeding and mulching or other appropriate means.
- T Regrade, if there is evidence of concentrated flow. Keep landscaped areas parallel to contours, if applicable.

### **Inspection:**

Inspect for:

- T Inspect for concentrated flows.
- T Sediment accumulation.
- T Adequacy of grass coverage in grassy filter strip.
- T Erosion in contributing drainage area.

For additional guidance, see attached **inspection checklist**.

Figure 6.20 Dry Swale (O-1)

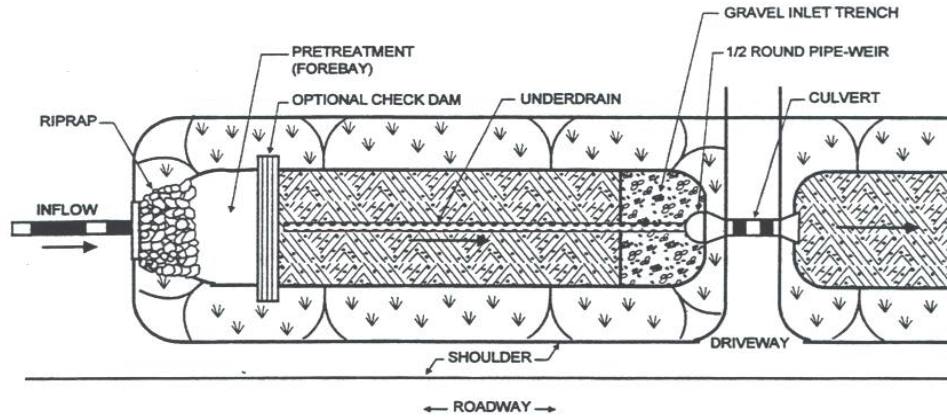

PLAN VIEW

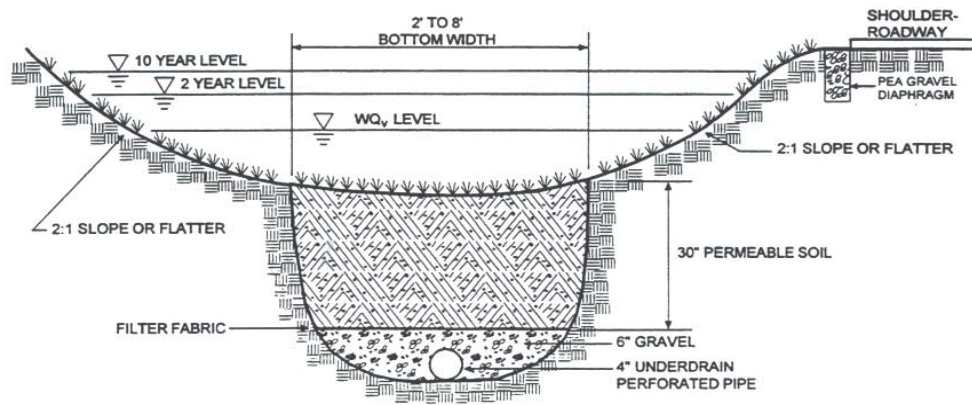

SECTION

## I. Dry Swale - DSW

---

**Description:** Open channel systems are vegetated open channels that are explicitly designed to treat stormwater. The channel is underlain by permeable soils and may have an underdrain system. This type of open channel may also contain checkdams.

**Structural Features:** Inflow, forebay, permeable soil layer, underdrain, outlet.

### **Maintenance:**

- T Periodically remove debris and litter.
- T Mow swale at least twice per year.
- T Periodically remove sediment in order to maintain original design depth.
- T Stabilize eroding soils on DOT right-of-way in the contributory drainage area by seeding and mulching or other appropriate means.
- T May require underdrain cleaning or repair.

### **Inspection:**

Inspect for:

- T Erosion in contributing drainage area.
- T Sediment accumulation.
- T Adequacy of grass coverage in swale.
- T Clogging of permeable soil layer and underdrain.

For additional guidance, see attached **inspection checklist**.

Figure 6.21 Wet Swale (O-2)

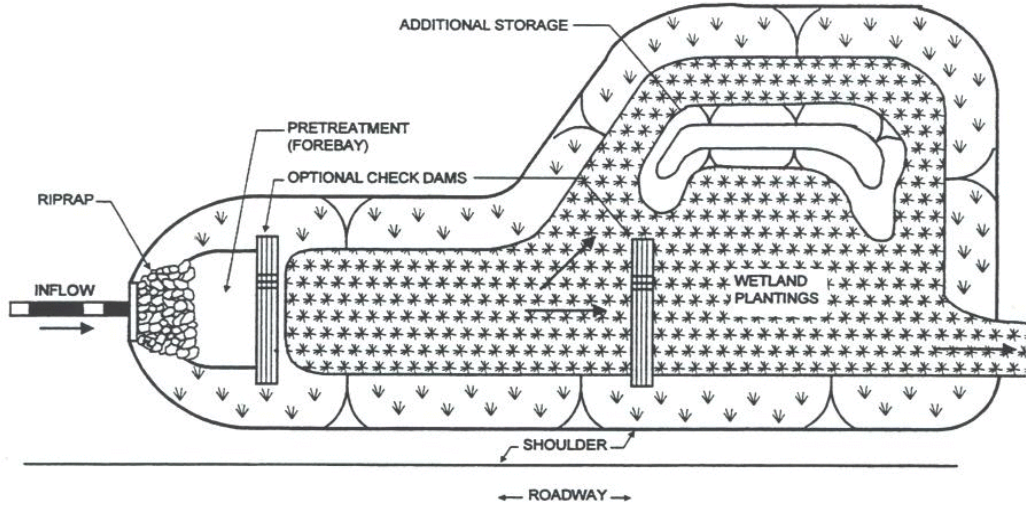

PLAN VIEW

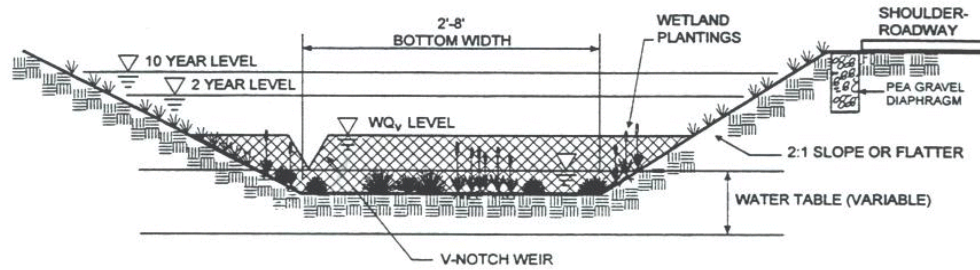

PROFILE

## **J. Wet Swale (with Checkdams) - WSW**

---

**Description:** A wet swale is a vegetated open channel that is explicitly designed to treat stormwater within wet cells formed by checkdams. The wet swale may be host to wetland plantings.

**Structural Features:** Inflow, forebay, checkdams, wetland plantings, outlet.

### **Maintenance:**

- T Periodically remove debris and litter.
- T Mow side slopes at least once per year, preferably after August.
- T Periodically remove sediment in order to maintain original design depth.
- T Stabilize eroding soils on DOT right-of-way in the contributory drainage area by seeding and mulching or other appropriate means.
- T May require wetland plantings replacements.

### **Inspection:**

Inspect for:

- T Erosion in contributing drainage area.
- T Sediment accumulation in swale, forebay and behind checkdams.
- T Adequacy of wetlands plantings coverage in swale.

For additional guidance, see attached **inspection checklist**.

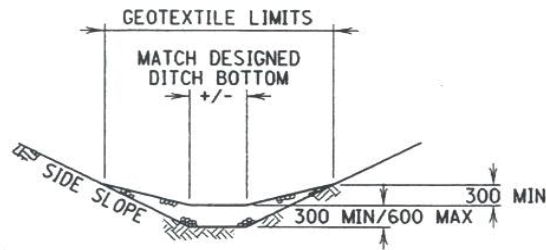
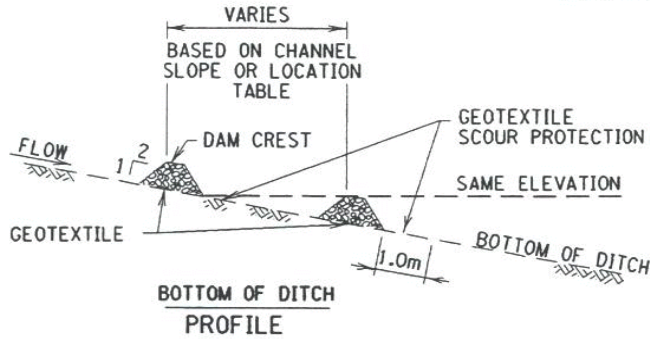

DITCH SLOPE	PLACEMENT INTERVAL
< 3%	35m
3-5%	25m
> 5%	15m

\*- PLACE AT THE END OF  
 DITCH CLEANING OPERATIONS

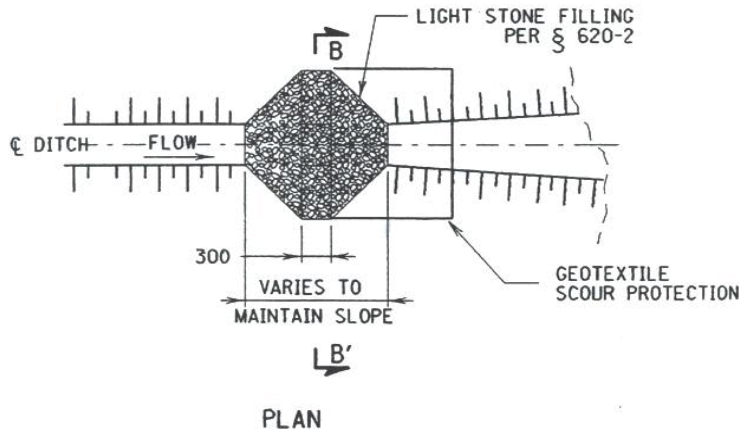

CHECK DAM (STONE) ITEM 209.0401 nn  
 (SEE TABLE BELOW FOR ITEM NUMBER TO BE USED.)

ITEM NUMBER	WIDTH OF BOTTOM OF DITCH
209.040101	LESS THAN OR EQUAL TO 1m.
209.040102	GREATER THAN 1m, LESS THAN OR EQUAL TO 2m.
209.040103	GREATER THAN 2m.

## **K. Checkdams - CD**

**Description:** Checkdams are designed to slow down the flow of water. Slow velocities cause sediment to drop out in front of the checkdam. Temporary checkdams can be made of stone, gravel/sand bags, and other materials. Permanent checkdams are usually made of light stone, but can also be earthen.

**Structural Features:** Inflow area, checkdam, overflow, outflow area.

### **Maintenance:**

- T Periodically remove debris and litter.
- T Remove sediment when it reaches 50% of checkdam height.
- T Repair/replace checkdams if necessary.
- T Stabilize eroding soils on DOT right-of-way in the contributory drainage area by seeding and mulching or other appropriate means.

### **Inspection:**

Inspect for:

- T Sediment accumulation in front of checkdams.
- T Erosion/scouring behind checkdam.
- T Proper checkdam configuration.
- T Erosion in contributing drainage area.

For additional guidance, see attached **inspection checklist**.

FILE NAME = V2300101.DWG  
DATE/TIME = 23-DEC-1999 11:46  
USER = ewehmann

WATERSHED HANDBOOK  
STANDARD DETAILS  
OIL/GRIT SEPARATOR

# OIL/GRIT SEPARATOR

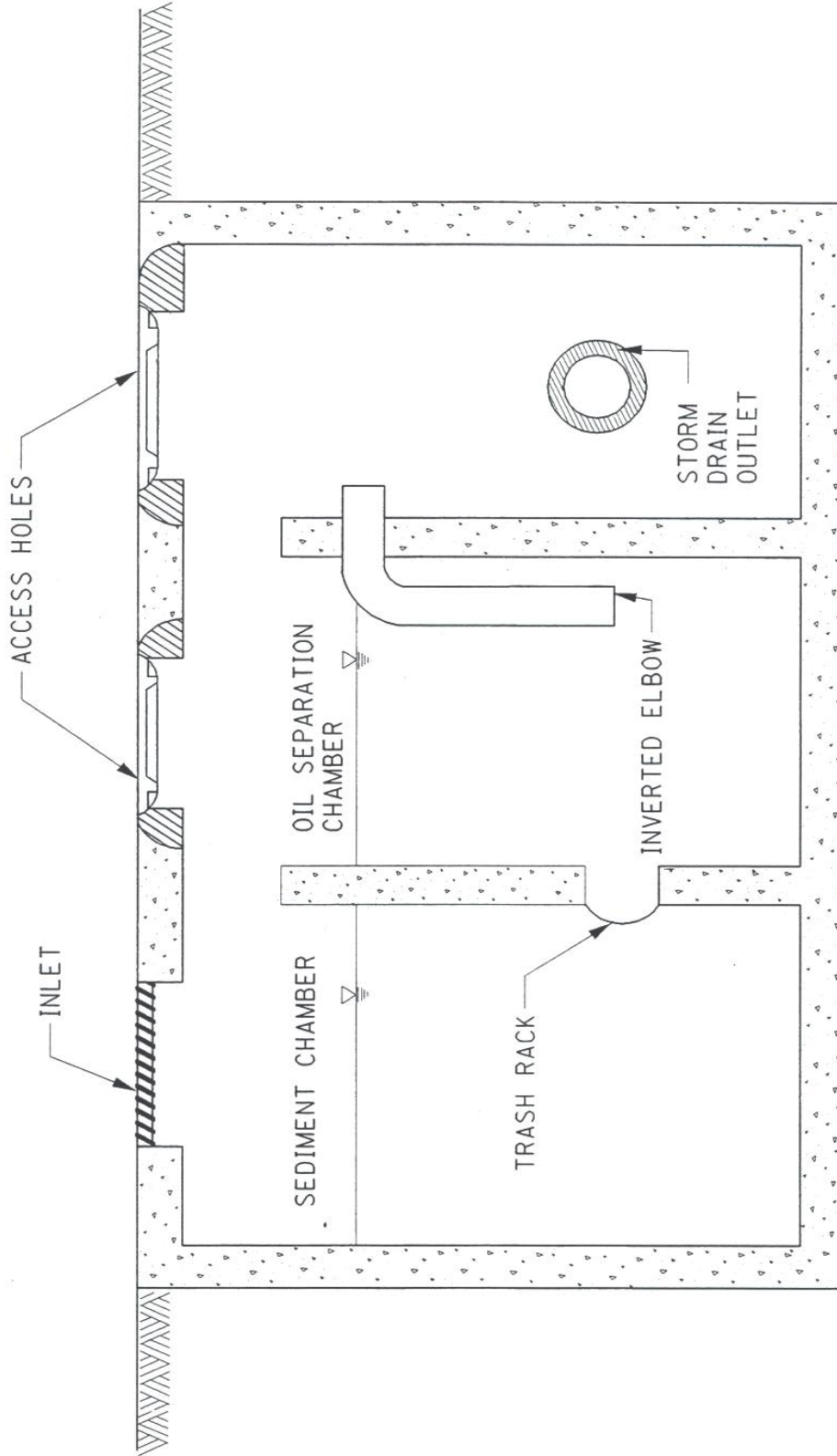

ALL DIMENSIONS ARE IN m UNLESS OTHERWISE NOTED



STATE OF NEW YORK  
DEPARTMENT OF TRANSPORTATION

12/99

REGION EIGHT

## L. Oil/Grit Separator - OGS

---

**Description:** Also described as water quality inlets, these devices can function in place of a drainage junction. Water enters a sediment chamber to drop out larger sediment particles, followed by an oil separation chamber and an outlet. These have uses on parking lots, urban areas and other special sites. Excellent pre-treatment tool.

**Structural Features:** Inlet, trash rack, sediment chamber, oil separation chamber, outlet chamber, maintenance access holes.

### **Maintenance:**

- T Clean sediment out annually or when sediment has reached a depth of 6 inches using a vactor truck or clamshell scoop. Use similar procedures to cleaning underground tanks, and catch basins.
- T Remove trash and debris.
- T Oil may be removed with oil absorbent pads at time of sediment removal. Lower water levels for this operation.
- T Caution: Oil/grit separators are confined spaces and any entry requires OSHA safety procedures (29 CFR 1910.146). Entry into the units is not required for routine maintenance operations.
- T The oil and sediment waste from the chambers is considered a non-hazardous industrial waste, which requires waste transporter permit requirements, but not a hazardous waste manifest. Transporting up to 500 lb of this waste is allowed in a single shipment without a waste transporter permit.
- T The oil collected from the separator could be handled with other liquid waste oil from a DOT facility.
- T Water from the chamber that has been separated from the oil by skimming could be reintroduced into the chamber after the cleaning operation. However, if the water is mixed with the oil, it should be added to the waste oil and treated as such.

### **Inspection:**

Inspect for:

- T Use a dipstick to check for sediment accumulation.
- T Some units have smaller inspection/cleanout pipes for oil removal. This pipe can also be used for inspection of the oil level.
- T Recommend using tool to open access manhole cover, flashlight and dipstick for inspection.

EXAMPLE: WATER QUALITY CATCH BASIN

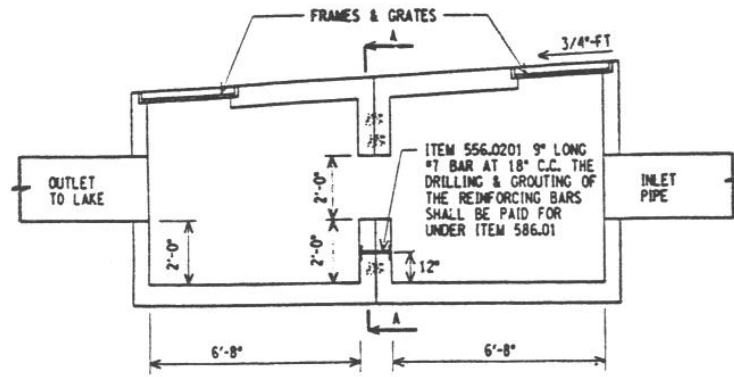

TWO TYPE "P" CB'S PLACED  
BACK TO BACK WITH 24" SUMPS  
SEE DRAINAGE TABLE FOR LOCATIONS

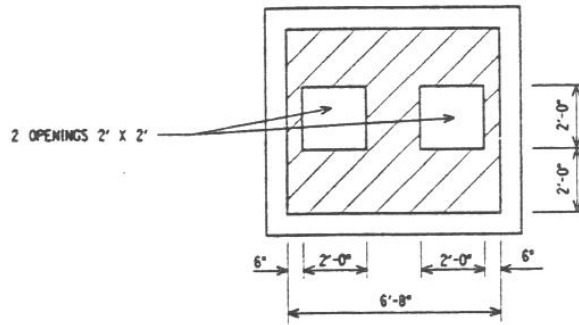

SECTION A-A

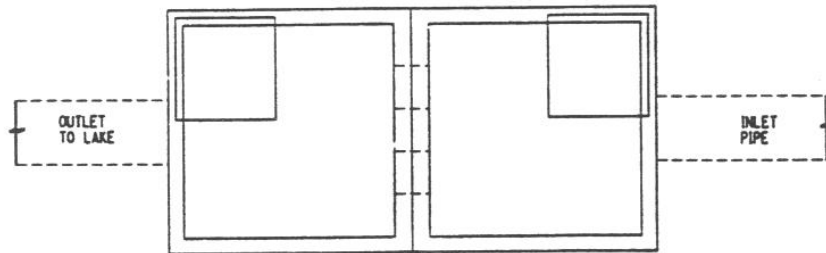

PLAN VIEW

## **M. Water Quality Catch Basin - QCB**

---

**Description:** Water quality catch basins are catch basins with sumps that allow sediment and debris to drop out before the water exits this drainage junction. Varieties include single and double catch basins.

**Structural Features:** Cover, catch basin, sump, pipes.

**Maintenance:**

T Cleanout annually, if sediment and debris have accumulated..

**Inspection:**

Inspect for:

T Visual check for sediment accumulation is usually sufficient.

T Recommend using tool to open cover, flashlight and dipstick for inspection of deep water quality catch basins.

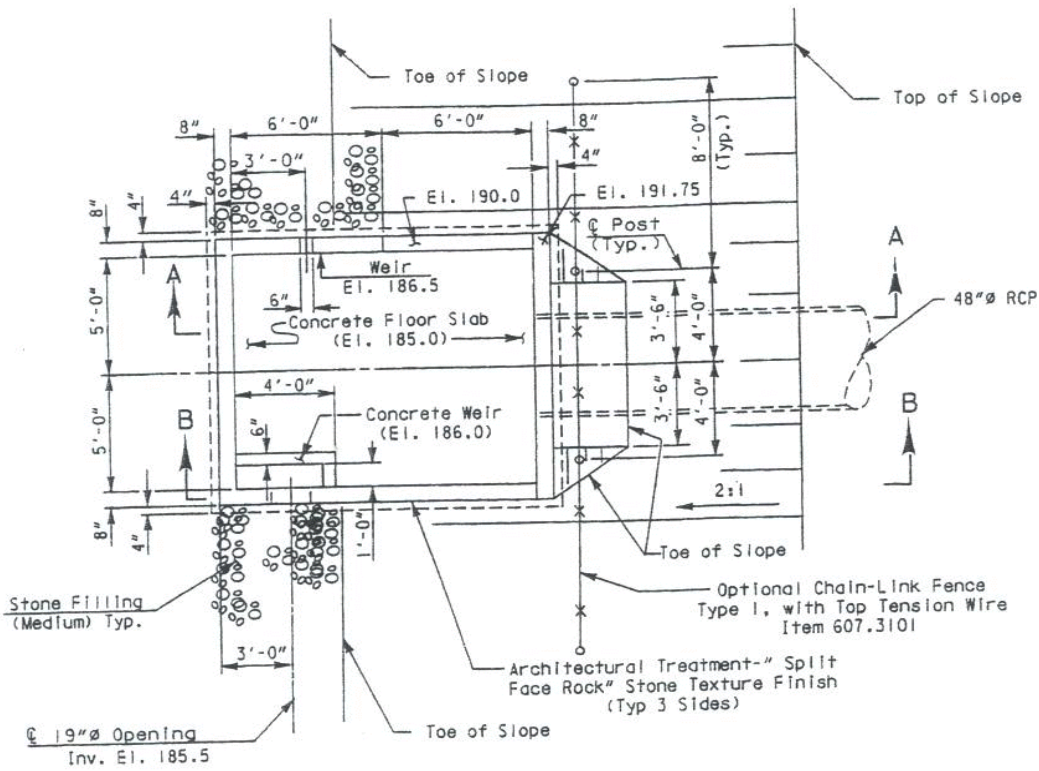

**PLAN** DR  
W-19  
Scale: 1/4" = 1'-0"

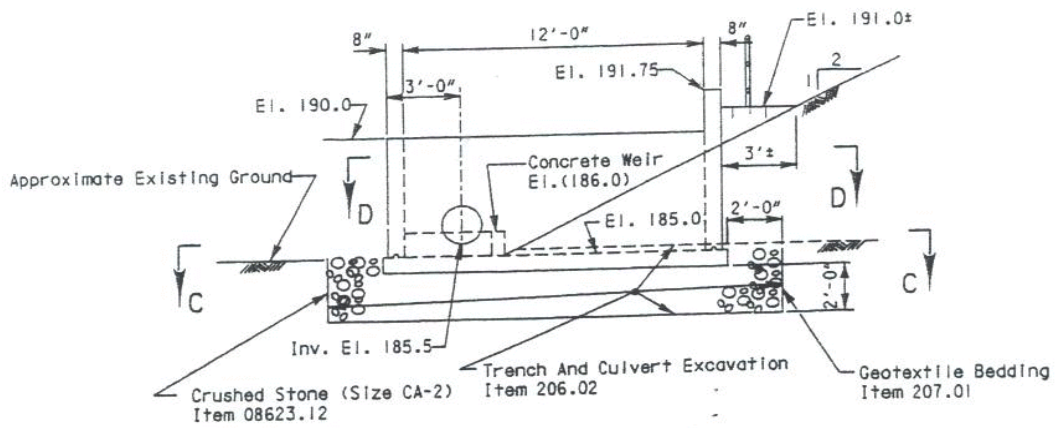

**SECTION B-B**  
Scale: 1/4" = 1'-0"

68/70

<b>SPECIAL DRAINAGE STRUCTURE DETAILS</b>	
<b>NOXON ROAD FLOW SPLITTER STRUCTURE</b>	
STATE OF NEW YORK DEPARTMENT OF TRANSPORTATION	
DRAWING NO. SDS-5	REGION 8

## N. Diversion Structure - DS

---

**Description:** Diversion structures, also known as flow splitters, can at times be necessary to divert large flows away from treatment facilities. Some flow splitters allow just a certain portion of stormwater to flow into a stormwater management facility. In addition, concerns with chloride loading from winter maintenance operations requires diversion structures that bypass meltwater from the treatment facility.

### **Maintenance:**

- T Clean sediment out annually or when sediment has reached a depth of 6 inches using a vactor truck or clamshell scoop. Use similar procedures to cleaning underground tanks, and catch basins.
- T Remove trash and debris.
- T Adjust gate for seasonal by-flows. Chloride and sediment-laden runoff is diverted from stormwater facility basins during the winter months.

### **Inspection:**

Inspect for:

- T Visual check for sediment accumulation is usually sufficient.

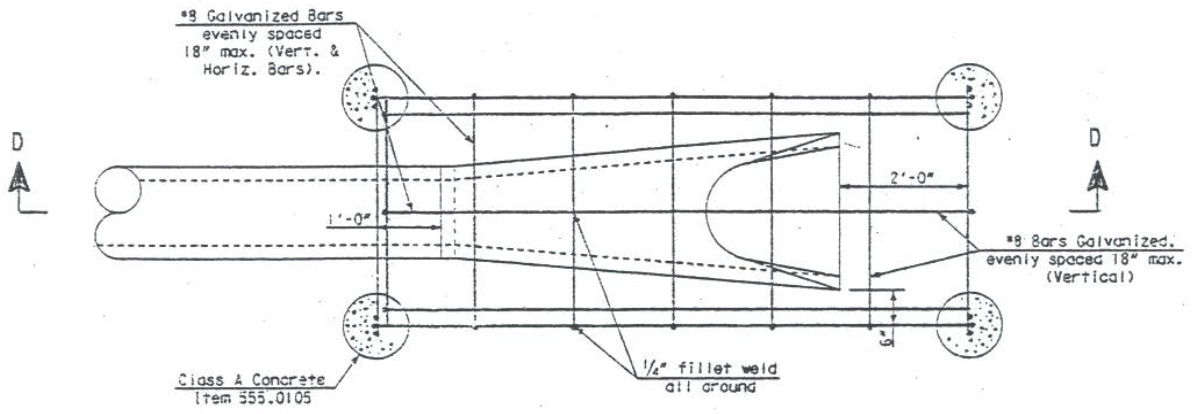

PLAN - END SECTION  
TRASH RACK  
Scale:  $\frac{3}{4}'' = 1'-0''$

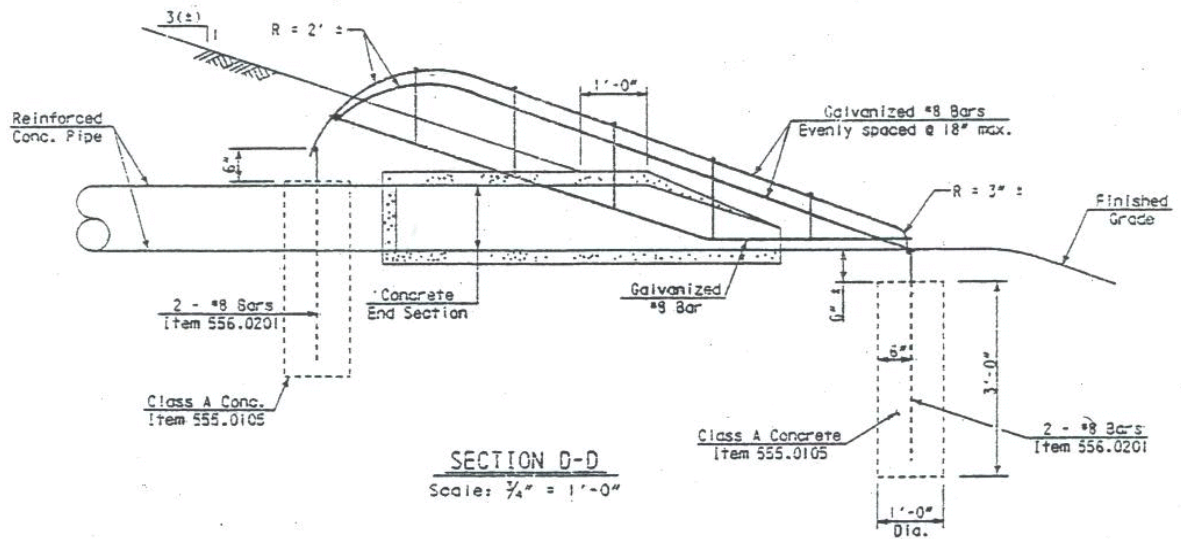

SECTION D-D  
Scale:  $\frac{3}{4}'' = 1'-0''$

## O. Trash Rack - TR

---

**Description:** A trash rack is as the name implies a “rack” intended to capture trash and debris. Trash racks can be placed into flowing water to protect inlets. Some racks are also placed at outlet pipes to prevent children from entering.

**Maintenance:**

T Clean trash rack when trash or debris have accumulated.

**Inspection:**

Inspect for:

T Visual check is sufficient.

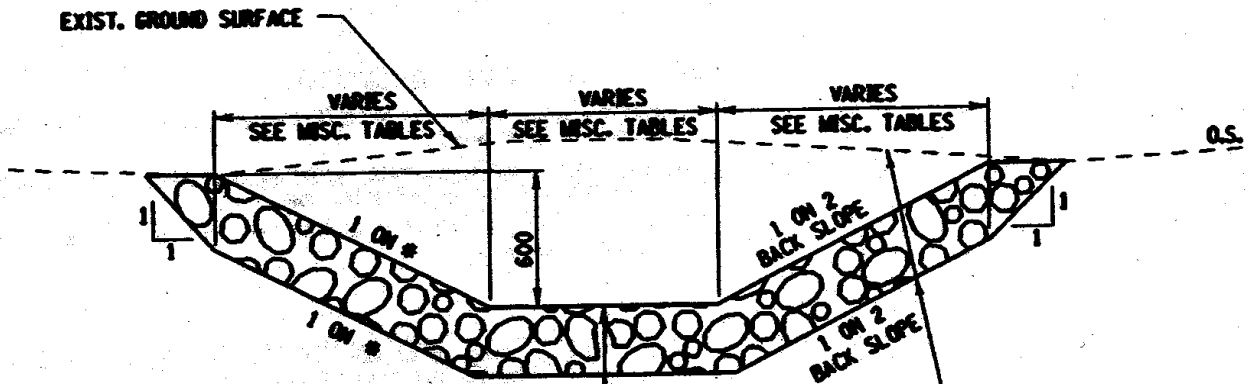

\* IF ADJACENT TO PAVEMENT USE 1 ON 3 SLOPE,  
OTHERWISE USE 1 ON 2 SLOPE.

300mm ITEM 620.02  
450mm ITEM 620.03  
600mm ITEM 620.04  
(USE ITEM 207.01 WITH ITEM 620.04)

ITEM 203.02

**STONE LINED DITCH  
SECTION VIEW**

**P. Stone-Lined Ditch - SD**

---

**Description:** A ditch lined with stone. Its purpose is to reduce velocity of concentrated flow and let sediment drop out in its interstices.

**Maintenance:**

T Clean when trash or debris have accumulated.

**Inspection:**

Inspect for:

T Visual check.

FILE NAME = c:\user\stbushee\sr\vr\k\water\std\grasswol.dtl  
 DATE/TIME = 16-MAR-2000 09:02  
 USER = tbushee

WATERSHED HANDBOOK
STANDARD DETAILS
GRASSED SWALE DETAIL

# GRASSED SWALE DETAIL

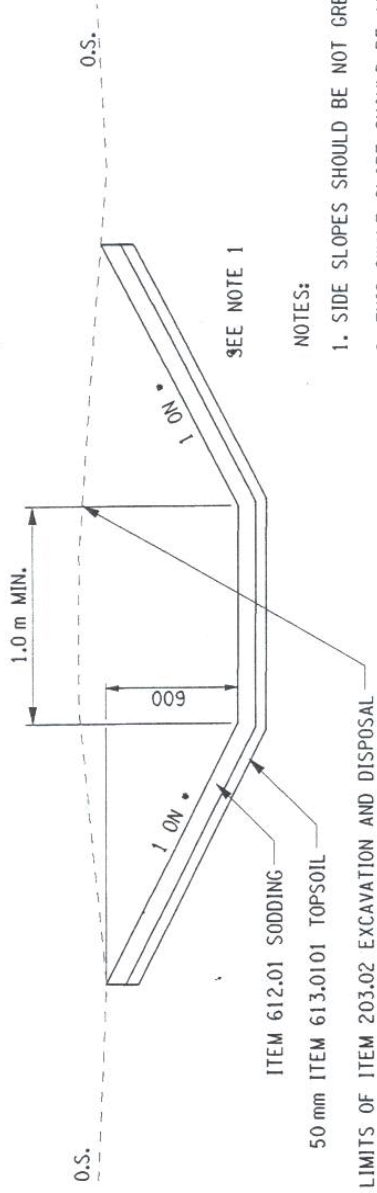

- NOTES:
1. SIDE SLOPES SHOULD BE NOT GREATER THAN 1 ON 3.
  2. THIS SWALE SLOPE SHOULD BE AS FLAT AS POSSIBLE TO MAXIMIZE INFILTRATION. FOR SLOPES GREATER THAN 4% MUST COMBINE WITH CHECK DAM.
  3. THE SWALE BOTTOM SHOULD BE A MINIMUM OF 1.0 m WIDE. WIDER BOTTOM WIDTHS WILL INCREASE INFILTRATION.
  4. SOILS SHOULD DESIRABLY HAVE A PERCOLATION RATE OF 0.5 INCHES PER HOUR.
  5. TO INCREASE INFILTRATION COMBINE GRASS SWALES WITH PERMANENT EARTHEN CHECK DAMS.

ALL DIMENSIONS ARE IN m UNLESS OTHERWISE NOTED



STATE OF NEW YORK  
 DEPARTMENT OF TRANSPORTATION

12/99

REGION EIGHT

**Q. Grass Channel - GC,  
with Checkdams - GCD**

---

**Description:** This facility describes the traditional ditch (GC) that may be lined with checkdams (GCD). This measure has some water quality benefits due to some infiltration within the channel and sediment removal in front of the stone checkdams. Usually underlain by native soils. Grass channels include grass swales and vegetated swales.

**Maintenance:**

- T Clean when trash or debris have accumulated.
- T Clean before checkdams when sediment has accumulated up to 50% of original checkdam height (see K.).
- T Repair any erosion gullies.

**Inspect for:**

- T Visual check for sediment and trash accumulation, structural integrity of checkdams.

**Page intentionally left blank for two-sided printing.**

**Stormwater Pond/Wetland**  
**including Detention Basin and Dry Pond**

**Operation, Maintenance and Management Inspection Checklist**

ID Number: \_\_\_\_\_

Location: \_\_\_\_\_

Date: \_\_\_\_\_

Inspector: \_\_\_\_\_

Maintenance Item	Satisfactory/ Unsatisfactory	Comments
<b>1. Embankment and emergency spillway (Annual, After Major Storms)</b>		
1. Vegetation and ground cover adequate		
2. Embankment erosion		
3. Animal burrows		
4. Unauthorized planting		
5. Cracking, bulging, or sliding of dam		
a. Upstream face		
b. Downstream face		
c. At or beyond toe		
downstream		
upstream		
d. Emergency spillway		
6. Pond, toe & chimney drains clear and functioning		
7. Seeps/leaks on downstream face		

Maintenance Item	Satisfactory/ Unsatisfactory	Comments
8. Slope protection or riprap failure		
9. Vertical/horizontal alignment of top of dam, As-Built.		
10. Emergency spillway clear of obstructions and debris		
11. Other (specify)		
<b>2. Riser and principal spillway (Annual)</b>		
Type: Reinforced concrete. _____ Corrugated pipe _____ Masonry _____		
1. Low flow orifice obstructed		
2. Low flow trash rack.		
a. Debris removal necessary		
b. Corrosion control		
3. Weir trash rack maintenance		
a. Debris removal necessary		
b. Corrosion control		
4. Excessive sediment accumulation inside riser		
5. Concrete/masonry condition riser and barrels		
a. Cracks or displacement		
b. Minor spalling (<1" )		
c. Major spalling (rebars exposed)		
d. Joint failures		
e. Water tightness		

Maintenance Item	Satisfactory/ Unsatisfactory	Comments
6. Metal pipe condition		
7. Control valve		
a. Operational/exercised		
b. Chained and locked		
8. Pond drain valve		
a. Operational/exercised		
b. Chained and locked		
9. Outfall channels functioning		
10. Other (specify)		
<b>3. Permanent Pool (Wet Ponds) (Annual)</b>		
1. Undesirable vegetative growth		
2. Floating or floatable debris removal required		
3. Visible pollution		
4. Shoreline problem		
5. Other (specify)		
<b>4. Sediment Forebays (Annual)</b>		
1. Sedimentation noted		
2. Sediment cleanout when depth < 50% design depth		
<b>5. Dry Pond Areas (Annual)</b>		
1. Vegetation adequate		
2. Undesirable vegetative growth		
3. Undesirable woody vegetation		

Maintenance Item	Satisfactory/ Unsatisfactory	Comments
4. Low flow channels clear of obstructions		
5. Standing water or wet spots		
6. Sediment and/or trash accumulation		
7. Other (specify)		
<b>6. Condition of Outfalls (Annual , After Major Storms)</b>		
1. Riprap failures		
2. Slope erosion		
3. Storm drain pipes		
4. Endwalls / Headwalls		
5. Other (specify)		
<b>7. Other (Annual )</b>		
1. Encroachment on pond, wetland or easement area		
2. Complaints from residents		
3. Aesthetics		
a. Grass growing required		
b. Graffiti removal needed		
c. Other (specify)		
4. Conditions of maintenance access routes.		
5. Signs of hydrocarbon build-up		
6. Any public hazards (specify)		
<b>8. Wetland Vegetation (Annual)</b>		

Maintenance Item	Satisfactory/ Unsatisfactory	Comments
1. Vegetation healthy and growing. Wetland maintaining 50% surface area coverage of wetland plants after the second growing season. (If unsatisfactory, reinforcement plantings needed).		
2. Dominant wetland plants: Survival of desired wetland plant species. Distribution according to landscaping plan?		
3. Evidence of invasive species		
4. Maintenance of adequate water depths for desired wetland plant species		
5. Harvesting of emergent plantings needed		
6. Have sediment accumulations reduced pool volume significantly or are plants choked with sediment		
7. Eutrophication level of the wetland.		
8. Other (specify)		

**Comments:** \_\_\_\_\_

\_\_\_\_\_

**Actions to be Taken:** \_\_\_\_\_

\_\_\_\_\_

\_\_\_\_\_

**Page intentionally left blank for two-sided printing.**

## Infiltration Practices

### (Trench and Basin)

#### Operation, Maintenance and Management Inspection Checklist

ID Number: \_\_\_\_\_

Location: \_\_\_\_\_

Date: \_\_\_\_\_

Inspector: \_\_\_\_\_

Maintenance Item	Satisfactory/ Unsatisfactory	Comments
<b>1. Debris Cleanout (Annual , After Major Storms)</b>		
Trench/basin surface clear of debris		
Inflow pipes clear of debris		
Overflow spillway clear of debris		
Inlet area clear of debris		
<b>2. Sediment Traps or Forebays (Annual)</b>		
Obviously trapping sediment		
Greater than 50% of storage volume remaining		
<b>3. Dewatering (Periodically)</b>		
Trench/Basin dewaterers between storms		
<b>4. Sediment Cleanout of Trench/Basin (Annual)</b>		
No evidence of sedimentation in trench/basin		
Sediment accumulation does not yet require cleanout		
<b>5. Inlets (Annual)</b>		
Good condition		

Maintenance Item	Satisfactory/ Unsatisfactory	Comments
No evidence of erosion		
<b>6. Outlet/Overflow Spillway (Annual)</b>		
Good condition, no need for repair		
No evidence of erosion		
<b>7. A. Aggregate Repairs - Trench Only (Annual)</b>		
Surface of aggregate clean		
Top layer of stone does not need replacement		
Trench does not need rehabilitation		
<b>B. Grass Repairs - Basin Only (Periodically)</b>		
Area mowed and clippings removed		
Absence of woody vegetation		

**Comments:**

---



---



---



---

**Actions to be Taken:**

---



---



---



---

## Sand and Organic Filter

### Operation, Maintenance and Management Inspection Checklist

ID Number: \_\_\_\_\_

Location: \_\_\_\_\_

Date: \_\_\_\_\_

Inspector: \_\_\_\_\_

Maintenance Item	Satisfactory/ Unsatisfactory	Comments
<b>1. Debris Cleanout (Periodically)</b>		
Contributing areas clean of debris		
Filtration facility clean of debris		
Inlet and outlets clear of debris		
<b>2. Oil and Grease (Periodically)</b>		
No evidence of filter surface clogging		
Activities in drainage area minimize oil and grease entry		
<b>3. Vegetation (Periodically)</b>		
Contributing drainage area stabilized		
No evidence of erosion		
<b>4. Water Retention Where Required (Periodically)</b>		
Water holding chambers at normal pool		
No evidence of leakage		
<b>5. Sediment Deposition (Annual)</b>		
Filter chamber free of sediments		
Sedimentation chamber not more than half full of sediments		

Maintenance Item	Satisfactory/ Unsatisfactory	Comments
<b>6. Structural Components (Annual)</b>		
No evidence of structural deterioration		
Any grates are in good condition		
No evidence of spalling or cracking of structural parts		
<b>7. Outlet/Overflow Spillway (Annual)</b>		
Good condition, no need for repairs		
No evidence of erosion (if draining into a natural channel)		
<b>8. Overall Function of Facility (Annual)</b>		
Evidence of flow bypassing facility		
No noticeable odors outside of facility		

**Comments:**

---



---



---



---

**Actions to be**

**Taken:**

---



---



---



---

## Bioretention Filter

### Operation, Maintenance and Management Inspection Checklist

ID Number: \_\_\_\_\_

Location: \_\_\_\_\_

Date: \_\_\_\_\_

Inspector: \_\_\_\_\_

Maintenance Item	Satisfactory/ Unsatisfactory	Comments
<b>1. Debris Cleanout (Periodically)</b>		
Bioretention and contributing areas clean of debris		
No dumping of yard wastes into practice		
Litter (branches, etc.) have been removed		
<b>2. Vegetation (Periodically)</b>		
Plant height not less than design water depth		
Plant composition according to approved plans		
No placement of inappropriate plants		
Grass height not greater than 6 inches		
No evidence of erosion		
<b>3. Check Dams/Energy Dissipaters/Sumps (Annual, After Major Storms)</b>		
No evidence of sediment buildup		
Sumps should not be more than 50%full of sediment		
No evidence of erosion at downstream toe of drop structure		

Maintenance Item	Satisfactory/ Unsatisfactory	Comments
<b>4. Dewatering (Periodically)</b>		
Dewaterers between storms		
No evidence of standing water		
<b>5. Sediment Deposition (Annual)</b>		
Swale clean of sediments		
Sediments should not be > 20% of swale design depth		
<b>6. Outlet/Overflow Spillway (Annual, After Major Storms)</b>		
Good condition, no need for repair		
No evidence of erosion		
No evidence of any blockages		
<b>7. Integrity of Filter Bed (Annual)</b>		
Filter bed has not been blocked or filled inappropriately		

**Comments:**

---



---



---



---

**Actions to be  
Taken:**

---



---



---

**Open Channel:  
Dry Swale, Wet Swale, Stone-Lined Ditch, Grass Channel**

**ID Number:**



**Comments:**

---

---

---

---

**Actions to be  
Taken:**

---

---

---

---

---

### STORMWATER FACILITIES - ACTIVATION AND INVENTORY FORM

Instructions: One form must be filled out per stormwater facility (stormwater pond, checkdam, etc.). Scroll to your section (Design, Construction, etc) and fill out each field. Check your data, then press the "Send" button. This will notify the Regional Environmental Contact (L. Weiss), Construction Environmental Coordinator (J. Ayers) and Maintenance Environmental Coordinator (E. Kolb) that the Activation and Inventory Forms have been sent. StormActForm12/03

#### DESIGN SECTION - BLUE/GREEN FIELD

Form Number 2 of 2

PIN 8220.01 D Number 000000 Project Manager Weiss

Project Name Rte 52/ Walkill

County Orange Town Walkill

Plan Sheet Nos 5, 10, 20

Route 52 Nearest Reference Marker 52-8703-5544 Offset (meters) 10 R/L: Right

Easting (off CADD) E490000 Northing (off CADD) N360000

SPDES - Check if "Yes"  Stormwater Management Goal Both New York City Watershed - Check, if "Yes"

DOT Jurisdiction - Check, if "Yes"  Jurisdiction, if not DOT

Facility Type Infiltration Basin, Grassy - IBG If "Other", Describe

Size (Height x Width x Length) in Meters 110x110x100 Centerline Station 20+300

Check, if Maintenance Complies with the "Operations and Maintenance Manual" Located at 0:\Regional\Shared\Maintenance\Environm   
If "No", State Specific Instructions Here. If "Yes", List Applicable Pages  
15 and 16

Design Information Submitted By Kolb Date 12/04/2003

#### CONSTRUCTION SECTION - BLUE FIELDS

Construction Begin (Year) State the Year Facility Went On-Line

Built According to Plan  As Built Available  If yes, List Plan Sheets

Construction Information Submitted By Date

MAINTENANCE SECTION - PINK FIELDS Serial Number 1

Maintenance Information Submitted By Date

## RAINFALL LIST BY COUNTY

24-Hour Rainfall Amounts (inches) for selected counties in New York State.

<b>COUNTY</b>	1 YR	2 YR	5 YR	10 YR	25 YR	50 YR	100 YR	Average Annual Rainfall
Columbia	2.5	3.0	4.0	4.7	5.5	6.0	7.8	39.9
Dutchess	2.8	3.5	4.5	5.0	6.0	7.0	8.0	40.2
Orange	2.9	3.5	4.5	5.5	6.5	7.0	8.0	48.0
Putnam	2.7	3.5	4.5	5.0	6.0	7.0	7.5	45.0
Rockland	2.7	3.5	4.5	5.0	6.0	7.0	7.5	51.2
Ulster	3.5	4.0	5.0	6.0	6.5	7.0	8.0	50.4
Westchester	2.8	3.5	4.5	5.0	6.0	7.0	7.5	49.5

Note: The frequency values listed below are average values for the County. In certain areas of a county, jobs may require higher or lower rainfall values.

## **REGION 8 CONTACTS:**

---

### **Regional Maintenance**

Maintenance Environmental Coordinator:

Elisabeth Kolb Tel. 845/575-6158

Regional Transportation Maintenance Engineer:

Eugene Pinto Tel. 845/575-6157

### **Residencies**

Resident Engineer 8-1 (Columbia County)

Robert Rice Tel. 518/828-9401

Resident Engineer 8-2 (Northern & Central Dutchess Cty)

Peter Teliska Tel. 845/454-3390

Resident Engineer 8-3 (Southern Dutchess & Putnam Cty)

Roger Griemsmann Tel. 845/878-6361

Resident Engineer 8-4 (Eastern Orange Cty)

Ken Dodge Tel. 845/562-4020

Resident Engineer 8-5 (Western Orange Cty)

Jennifer Clark Tel. 845/343-4638

Resident Engineer 8-6 (Rockland County)

Robert Falk Tel. 845/634-4661

Resident Engineer 8-7 (Ulster County)

Keith Savoury Tel. 845/331-5533

Resident Engineer 8-8 (Northern Westchester County)

Michael McBride Tel. 914/232-3060

Resident Engineer 8-9 (Southern Westchester County)

Joseph Schiraldi Tel. 914/592-6557

### **Other Region 8 Environmental Staff:**

Regional Environmental Contact:

Lisa Weiss Tel. 845/431-5852

Construction Environmental Coordinator:

James Ayers Tel. 845/575-6120